

RUBBER LAGGING SECTION AT Y-Y

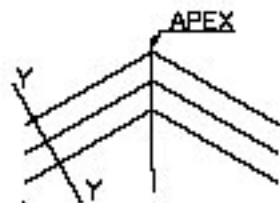

NOTE:- FOLLOWING OPTIONS ON REQUEST

1. CROWNING
2. TYPES OF GROOVING LIKE DIAMOND / HERRINGBONE / CHEVRON GROOVING
3. LAGGING MATERIAL : NATURAL / NEOPRENE RUBBER

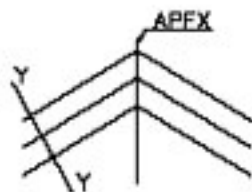
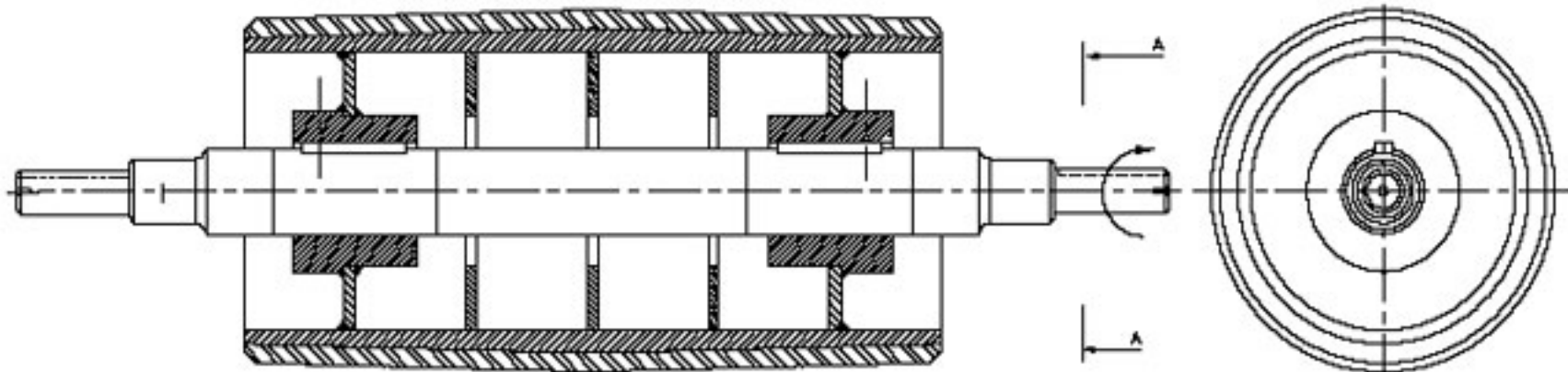

SECTION A-A RUBBER LAGGING SECTION AT 'Y-Y'

NOTE:- FOLLOWING OPTIONS ON REQUEST

1. CROWNING
2. TYPES OF GROOVING LIKE DIAMOND / HERRINGBONE / CHEVRON GROOVING
3. LAGGING MATERIAL : NATURAL / NEOPRENE RUBBER

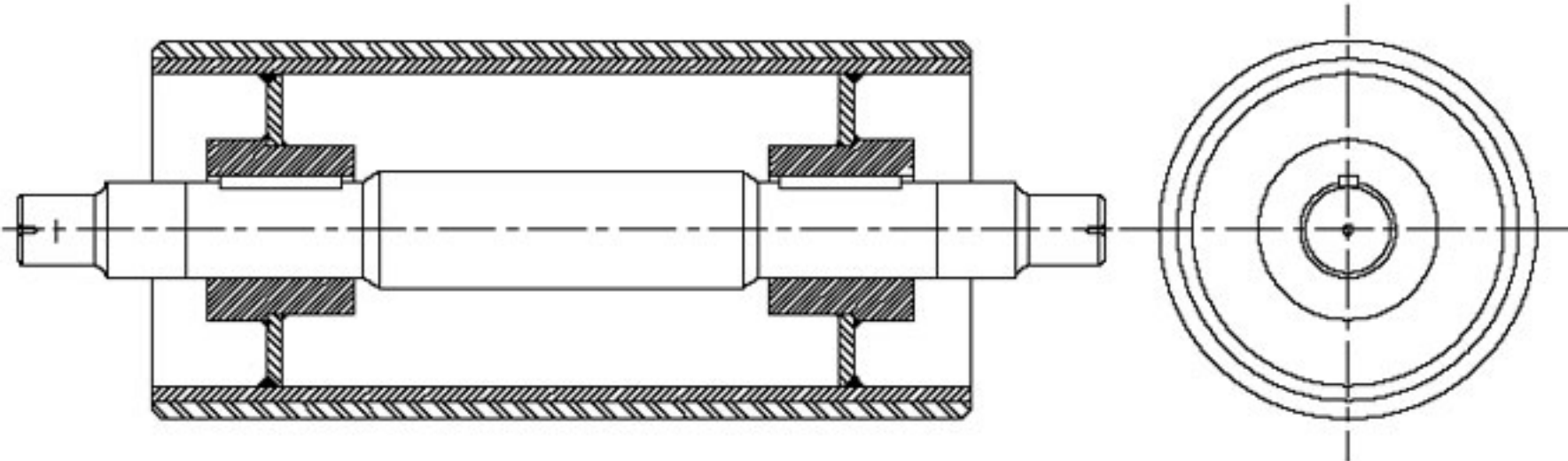

RUBBER LAGGING SECTION AT 'Y-Y'

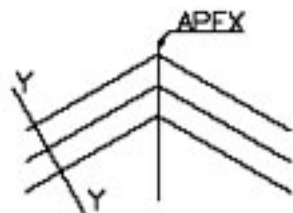

NOTE:- FOLLOWING OPTIONS ON REQUEST

1. CROWNING
2. TYPES OF GROOVING LIKE DIAMOND / HERRINGBONE / CHEVRON GROOVING
3. LAGGING MATERIAL : NATURAL / NEOPRENE RUBBER.

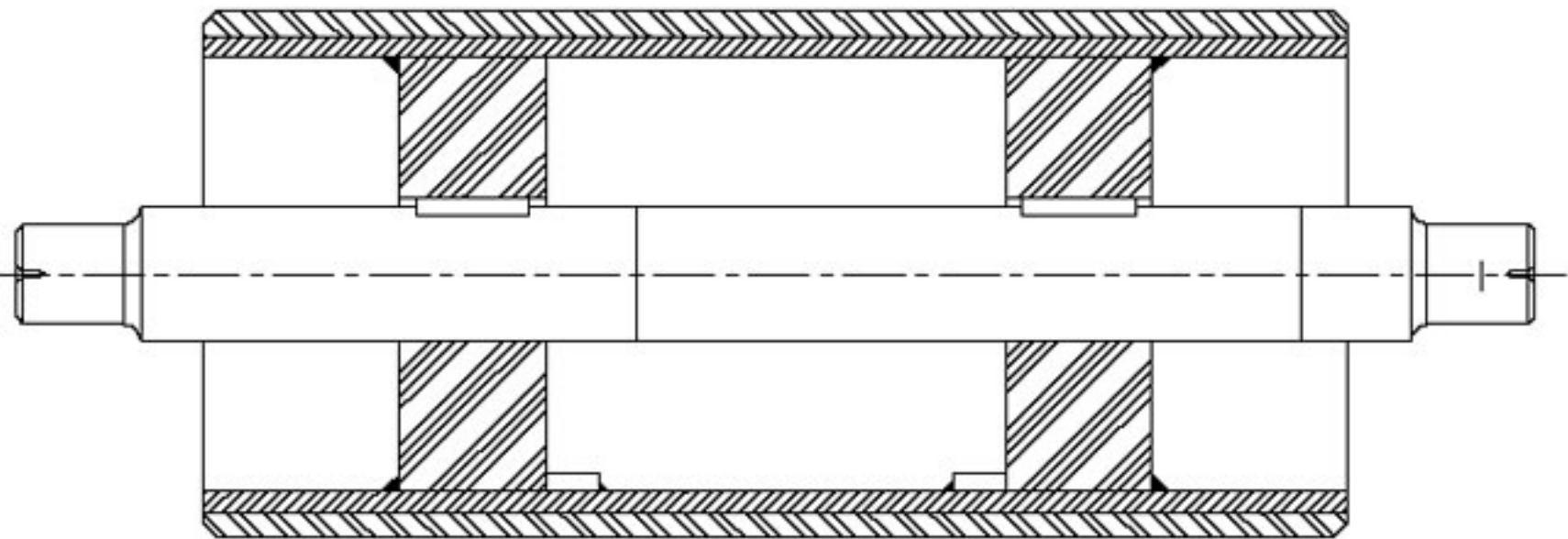

RUBBER LAGGING SECTION AT 'Y-Y'

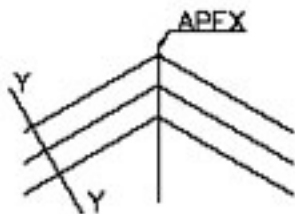

NOTE:- FOLLOWING OPTIONS ON REQUEST

1. CROWNING
2. TYPES OF GROOVING LIKE DIAMOND / HERRINGBONE / CHEVRON GROOVING
3. LAGGING MATERIAL : NATURAL / NEOPRENE RUBBER